



INDeX

Standard Telephone Guide



Contents

Introduction	3
Telephone Features	4
Quick Summary	6
Making Calls	8
Speed Dials, PIN's & Account Codes	10
Busy or Unanswered	12
Answering Calls	14
Transfer, Park & Hold Calls	16
Diverting Calls	18
Other Features.....	20
Voice Manager	22
Good Phone Usage	24
Telephone Numbers.....	25
Glossary	26
Index.....	27

Introduction

Using this Guide



This guide covers the use of standard telephones on the INDeX telephone system. The term 'standard telephones' means normal domestic telephones (and similar devices such as fax and answer machines). For full details of the types of phone you can use and in which phone sockets see "Telephone Features" on page 4.

What Features Can I Use?

This guide details all the features that the system supports for standard phones. However, your phone may not be able to use all the features. Which it can use depends on the phone's type and other settings.

Your phone may also have additional features provided by its manufacturer (eg. redial, stored numbers keys). This guide cannot cover those features, instead you must refer to the phone manufacturer's information.

Further Help

"Why don't you do something to help me?"
Stan Laurel 1947.



In all instances, first seek help from your System Manager. They will seek further assistance from your system's Maintainer if necessary.

System Manager: on Extension:

This guide is also available in several computer *formats* (eg. *Windows Help*, *Adobe Acrobat*). Contact your System Manager to obtain copies or download them from the Lucent Technologies internet site (<http://www.sdxplc.com>).

FT Mode Operation

Versions of INDeX software before Software Level 8.0 (*the version covered by this guide*) supported two modes of operation, ie. the sequences of key presses required for different features.

Level 8.0 INDeX software supports only one mode of operation (equivalent to the **DT** mode in previous INDeX software).

Telephone Features

Which Telephone Can You Use?

The standard phone must meet the requirements listed below. You must also only use it in the phone socket indicated by your System Manager. Standard phones will not work in INDeX feature phone sockets and vice versa.

MF - Alias:

- DTMF
- Tone dialling

LD - Alias:

- Loop disconnect

MF or LD Dialling

Phones use either **LD** or **MF** dialling. Each time you dial a number, **MF** dialling sends a tone whilst **LD** dialling sends a series of clicks.

We recommend **MF phones**. They have * and # keys plus a **RECALL** key (sometimes just marked **R**). These allow you to use more of the system's features. MF dialling also provides quicker dialling and call setup both on the system and on the public phone network.

Many modern phones can switch to either mode. Refer to the phone manufacturer's instruction for details of how to switch the phone between LD and MF.

Time Break Recall

During a call, phones use a recall signal to indicate to the exchange that they are about to send more digits. MF phones use either Time Break Recall (**TBR**) or Earth Recall (**ER**). For an MF phone's **RECALL** key to work on the INDeX system, it **must** use **TBR**. Refer to the phone manufacturer's instructions to see how to set it to TBR.

Sharing Sockets

REN - Alias:

- Ringer equivalence number

All standard telephone devices have a REN value. This value is a measure of how much current they need to ring and operate properly when a call arrives.

INDeX standard telephone sockets provide a REN of 2. Thus you can share the socket between several standard telephone devices (eg. a phone and an answer machine) so long as their total REN does not exceed 2. Alias.

Telephone Tones & Ringing

The phone uses various tones and ringing to indicate calls and other events.

Incoming Calls:

- **Repeated Double Ring:** External call.
- **Repeated Single Ring:** Internal call.

During Calls:

- **Repeated Single Pip:** Another extension is about to intrude or has intruded on your call.

Outgoing Calls:

- **Continuous Tone:** Number called unobtainable or set to no calls. Phone locked, no external calls (or phone is barred).
- **Repeated Tone:** Busy number (*see page 12*).
- **Dial Tone:** Dial number.
- **Repeated Single Pip:** Phone on divert or no calls (*see page 18*).

Night Service

The system takes different areas into and out of night service automatically. It does this following timetables setup by the System Manager. The effects of night service vary, but typically they are as follows:

- **Lines:** The system directs calls to a night desk number or answer phone extension.
- **Phones:** The type of calls you can make becomes more restricted, eg. no international or long distance calls.

Dialling Timeout

After you start dialling, if you do not dial another digit for several seconds the system assumes that you have finished dialling. The system then ignores any further digits that you dial. By default the timeout is 5 seconds though this can be altered.

Since it is your phone that generates the audible dialling tones, the system's dialling timeout does not affect calls connected through the system to services that need to hear additional MF tones (eg. voice mail systems, BT star services, etc).

Quick Summary

Introduction



 = Replace handset.

 = Lift handset.

<value> = Enter value required (eg. , phone number).

<pass> = Enter phone passcode (4-digits).



(note) = Note.

X...Y = Enter value in the range X to Y.

Making Calls

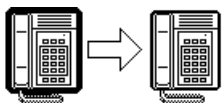
For full details, see page 8.



To make an external call: , 9, <external number>, (after call) 

To make an internal call: , <extension number>, (after call) 

To redial the last external number: , #, * (includes speed dials)

To make a page call: , *, 7, <group number>, speak, (after call)



Speed Dials

For full details, see page 10.



To use a system speed dial: , #, 100...899 or 9000...9999

To use a personal speed dial: , #, 00...09

To store a personal speed dial:

For external numbers, put 9 before the number.

, *, 0, 00...09, <pass>, *, <no.>, #, 

If Busy or Unanswered

For full details, see page 12.

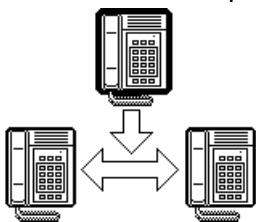

To leave a message: 1, 

This lights the lamp on the extension called and leaves your number as a message to reply (unless they have reached their limit of 5 messages).

To set a call back: 2, 

This rings you when that extension becomes free or is next used.

To camp on & wait: 3



This flashes the lamp on the busy phone if an INDeX feature phone.

To cancel camp on: 

Ringer Controls

For full details, see page 20.



Ringer Timeout: , *, 0, 1, 3, <pass>, * (clear), <time>, #, 

Affects Callback, Group Ringing and Divert on No Answer

Answering Calls

For full details, see page 14.

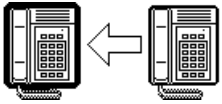

To answer a call: ☎

To pickup calls: ☎, RECALL, #

To use this feature you must first have a pickup group number set.

To set pickup no.:

You can set a group or extension as your pickup number.

☎, *, 0, 4, 2, <pass>, * (clear), <group no.>, #, ☎

Transfer, Park & Hold Calls

For full details, see page 16.

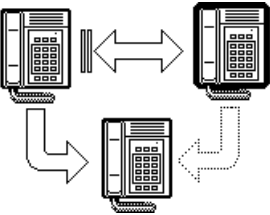

To transfer a call: RECALL, <extension no.>, ☎

To hold/unhold a call: RECALL

Note: Replacing the handset parks the held call or transfers it if on another call.

To park call: RECALL, ☎

To retrieve a call you parked: ☎, *, 9

To retrieve a call parked elsewhere: ☎, <line no.>

Diverting Calls

For full details, see page 18.

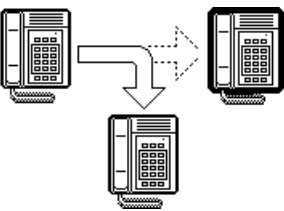

Setting a divert number also switches its use on. Clearing the divert number switches it off.

To set a divert all:

☎, *, 0, 1, 0, <pass>, * (clear), <extension no.>, #, ☎

To set a divert on busy number:

☎, *, 0, 1, 1, <pass>, * (clear), <extension no.>, #, ☎

To set a divert on no answer number:

☎, *, 0, 1, 2, <pass>, * (clear), <extension no.>, #, ☎

To switch no calls on/off:

☎, *, 0, 6 plus 0 (on) or 1 (off), ☎

Other Features

For full details, see page 20.



Set passcode:

☎, *, 0, 7, 0, <old passcode>, *, <new passcode>, ☎

Enter/exit group:

☎, *, 0, 4 plus 0 (enter) or 1 (exit), ☎

To set a personal alarm:

☎, *, 8, *hhmm*, # where *hhmm* is the time in 24 hour format.

To clear an alarm: ☎, *, 8, *, #

Making Calls

Notes on Making Calls

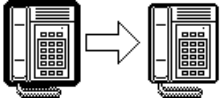

Your phone allows very simple and quick dialling to make calls. To simplify dialling further, the system can store several hundred speed dials for use by any extension. It can also store personal speed dials for your own frequently needed numbers.

– **Call Barring**

On external calls, the system may bar you from dialling particular numbers or types of numbers (eg. national, international). Typically, call barring increases when the system puts the phone's area into night service. Call barring can also change according to time, date and day of the week. As the call barring settings vary for each site, this guide cannot fully detailed their effect.

Making External Calls

"E.T. phone home" Steven Spielberg 1982.

Redial - Alias:

- Last number redial
- Saved number redial.

The method below uses normal dialling to make external calls. The system may apply call barring to some or all external numbers. You can also lock your phone by wrong passcode entry (*see page 20*).

To dial an external call:

1. Lift the handset and dial **9** (*Your System Manager will inform you if you need to dial a different number*).
2. If you hear a repeated single pip, the system requires a PIN code or account code before allowing an external call (*see page 10*).
3. Dial the telephone number.
4. During the call you can do hold or transfer it (*see page 16*).
5. To end the call replace the handset.

To redial last external number used:

1. Lift the handset and dial **# *** to repeat the last external number used (including speed dials).

Making Internal Calls

"Hello, Neil and Buzz. I'm talking to you by telephone from the Oval Room at the White House, and this certainly has to be the most historic telephone call ever made." **Richard Nixon 1969.**



To dial an internal call:

1. Lift the handset and dial the extension or group number.
2. If you hear continuous tone, to leave your number as a message, dial **1** (*see page 12 for full details*).
3. If you hear just ringing, either leave a message as above or to set a callback, dial **2** (*see page 13 for full details*).
4. If you hear busy tone, either leave a message or set a callback as above. Otherwise, to camp on and wait, dial **3** (*see page 13 for full details*).
5. To end the call, replace the handset.

Making a Page Call

Page Call - Alias:

- Broadcast
- Zone paging.

You can page any free INDeX DT or TT phones or group of such phones. They hear the call without doing anything though you cannot hear them. If wanted, they can turn the page into a normal call. If the extension you page is diverting calls, the page also diverts (except group pages).

To page an extension or group:

1. Lift the handset and dial ***7**.
2. Dial the extension or group number.
3. If you hear busy or continuous tone, you can use the same options as for a normal internal call (*see page 12*).
4. Speak and then replace the handset.

Hotline Operation

Hotline operation allows the phone to automatically dial a number when left off-hook for a set period. Your System Manager or maintainer controls the settings for this feature.

Speed Dials, PIN's & Account Codes

Using Speed Dials



Speed Dials - Alias:

- Abbreviated dialling

The system can store telephone numbers as speed dials. You can then ring those numbers by dialling the number of the speed dial store.

- **System speed dials:** All extensions can use these, though call barring may still apply. Ask your System Manager for a list.
- **Personal speed dials:** You can store up to 10 speed dials for your own use (*see below*).

To use a speed dial:

1. Lift the handset and dial #.
2. Dial the speed dial store number (00 to 09 for personal speed dials, 100 to 899 and 9000 to 9999 for system speed dials).
3. If the phone gives a repeated single-pip, it requires a PIN or account code before allowing the call.
4. Continue as for a normal external call (*see page 8*).

Storing Personal Speed Dials

If external, prefix **9** to the stored number, this is the normal number to seize an external line. Your System Manager will inform you if you have to add a different prefix number.

To store a personal speed dial number:

1. Lift the handset and immediately dial *0.
2. **Broken dial tone:** Dial the speed dial store to use (**00** to **09**).
3. **Loud pip:** Dial the phone's passcode (*see page 20*).
4. **Continuous tone:** Passcode wrong, replace handset.
5. **Three soft-tones:** Number already set, dial * to cancel.
6. **Single soft tone:** No number set, dial a number and #. Then replace the handset.

Forced Account Code Entry

A repeating single-pip when making an external call may indicate that you must dial an account code before continuing (check with your System Manager). If so, the system checks the code you dial against its list of codes before allowing the call. The system can store up to 200 12-digit codes. Ask your System Manager for a list of valid codes.

To enter a forced account code:

1. Dial an account code
2. If you make a mistake, dial * and try again.
3. Then dial the external number required.

Forced PIN Code Entry

A repeating single-pip when making an external call may indicate that you must dial a PIN code before continuing (check with you System Manager). If so, the system checks the code you dial against its list of codes before allowing the call. The PIN code you use also sets your call barring and phone status for that call. The system stores up to 200 PIN codes of up to 6 digits. Ask your System Manager for a list of valid PIN codes.

To enter a PIN code:

1. Dial your PIN code
2. If you make a mistake, dial * and try again.
3. **Continuous tone:** Code not recognised, end the call.
4. **Silence:** Code accepted, continue the call as normal.

Roaming Pins

Roaming PINs - Alias:

- Mobile access.

You can use a PIN code and its associated phone & call barring settings to override the restriction on another normal phone. Note that when you do this, the system automatically force the call to be external.

To use a roaming PIN:

1. Lift the handset and dial *6.
2. **Repeated single pip:** Dial your PIN code. If you make a mistake, dial * and dial the number again.
3. **Continuous tone:** Code not recognised, end the call.
4. **Silence:** Code accepted, continue the call as normal.

Busy or Unanswered

If Busy or Unanswered

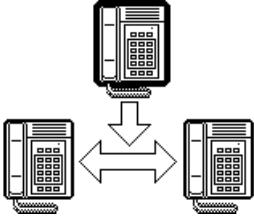

Your phone provides several methods for contacting an extension that is busy, not answering or set to no calls. These options work for normal, page and diverted calls.

- **Leave a Message:**
Lights the lamp of the extension called. That extension also stores (and displays if a display phone) your number as a message to reply.
- **Callback:**
Rings your phone when that extension called becomes free or is next used.
- **Camp On:**
Flashes the lamp on the extension called to notify them that you are waiting. It also stops other calls interrupting you.

Leaving a Message

The system can store your extension number as a message for another extension to call you. If that extension has a message lamp, the system also lights the lamp (*supported on all INDeX DT and TT phones plus some standard telephones*). If your call was diverted, the message goes to the extension from which you were diverted.

To leave a message:

1. Dial 1.
2. Your call ends unless the extension called has already reached its limit of 5 stored messages.
3. Replace the handset.

Arrange a Callback

Callback - Alias:

- Ringback.
- Call back when free.
- Call back when next used.

If the extension you call is busy or does not answer, you can set a callback. When that extension becomes free or is next used, your phone rings. When you answer, the other extension rings. After setting a callback you can make other calls, the callback will not take place if you are busy. You can only arrange one callback at any time.

The Ringer Timeout sets how long a callback rings at your extension before cancelling (*see page 20*). The system also cancels callbacks that have not taken place after a period set by the System Manager (the default is 2 hours).

To arrange a Call Back:

1. Dial **2**.
2. The system ends your call unless you already have a callback set.
3. Replace the handset.

Camp On and Wait

Camp On - Alias:

Wait on busy.

If the extension you call is busy, you can 'camp on' and wait. This flashes the lamp on the busy extension if it is an INDeX phone. If it is an INDeX display phone, the display shows your name and number. While camped on, you cannot make or receive any other calls.

To Camp On to a busy extension:

1. Dial **3**. **Do not** replace the handset as this ends the call and the camp on.

Answering Calls

Answering Normal Calls

"Phone call from God ...if it had been collect, it would have been daring" Robin Williams (Dead Poet Society 1989)

The phone gives a repeated double ring for external calls, a repeated single ring for internal calls.

To answer the call:

1. Lift the handset.
2. To end the call, replace the handset.

Answer a Message

The system can store a callers number for you to make a return call (*see page 12*). Some standard phones have a message lamp which the system can light when a caller leaves such a message.

If your system has a Voice Manager attached, this can also leave its number as a message when you have new voice mail waiting in your mailbox.

To answer a message waiting lamp:

1. Lift the handset and dial *1. The system rings the extension that left the message.

To cancel a message waiting lamp:

1. Lift the handset and dial *2. Replace the handset.

Answering Other Extensions - Call Pickup

Pickup - Alias:

- Call pickup.
- Take.

Your phone can store a pickup group number (*see below*). You can then pick up calls ringing any phone in that group.

To pick up ringing phones:

1. Lift the handset and dial **RECALL#** to pickup the longest ringing call.
2. Continue the call as normal.

To set the phone's pickup group:

1. Lift the handset and immediately dial ***0**.
2. **Broken dial tone:** Dial **42** (*pickup group*).
3. **Loud pip:** Dial the phone's 4-digit passcode (*see page 20*).
4. **Continuous tone:** Passcode wrong, replace the handset.
5. **Three soft-tones:** Pickup group set, dial ***** to cancel it.
6. **Single soft tone:** No pickup group set, dial a group number and then dial **#**.
7. **Continuous tone:** Invalid number, replace the handset.
8. **Broken dial tone:** Number okay, replace the handset.

Transfer, Park & Hold Calls

Using Transfer, Park & Hold

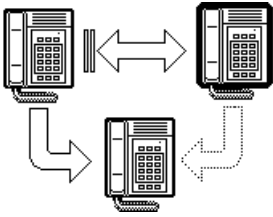

After answering a call, you can hold it or transfer it. You can also make an enquiry call and then switch between calls. You can hold a call (where only you can retrieve it) or park the call (where other extensions can retrieve it). Remember that calls transferred to an extension with diverts set, follow those diverts just like normal calls.

Transferring Calls

You can transfer a call to an extension that is ringing or giving busy tone. If the call waits unanswered for too long it may recall to your extension.

To do an unannounced transfer:

1. Dial **RECALL** to hold your current call. Do not replace the handset as this parks the call (*see page 17*).
2. Dial the extension to which you want to transfer the call.
3. Replace the handset (you can do this even if you hear ringing or busy tone).

To do an announced transfer:

1. Dial **RECALL** to hold your current call. Do not replace the handset as this parks the call (*see page 17*).
2. Dial the extension to which you want to transfer the call.
3. If unanswered, dial **RECALL** to retrieve the held call.
4. If answered, ask if they wish to accept the transfer.
5. If okay to transfer the call, replace the handset.
6. If not okay to transfer the caller, dial **RECALL** to retrieve the held call.

Parking Calls

Park - Alias:

- Common hold.

Any extension can retrieve a parked call by dialling the line number if known. You can park several calls. Calls parked and not retrieved, may recall your extension after a short time.

To park an external call:

1. During the call, dial **RECALL** and replace the handset.

To unpark calls parked at your extension:

1. Lift the handset and dial *9.

To unpark a call parked at another extension:

1. Lift the handset and dial the parked calls line number.

Holding Calls

Ring Transfer - Alias:

- Ring inward transfer.

Hold - Alias:

- Exclusive hold.
- Call hold.

Switch calls - Alias:

- Toggle calls.
- Brokers call.

Only the extension that holds a call can retrieve it unless they transfer the call. When you hold a call, the caller may hear music if installed on your system. You can only hold one call at a time. You can transfer a call to an extension that is ringing or giving busy tone. If the call waits unanswered for too long, it may recall to your extension.

To hold a call:

1. Dial **RECALL**.
2. If you now replace the handset, the system parks the call (*see previous page*).
3. Retrieve the call by dialling **RECALL** again or while holding the call, make another call (enquiry call) and:
 - To switch between calls, dial **RECALL**.
 - To transfer the held call, replace the handset.

Diverting Calls

Using Diverts

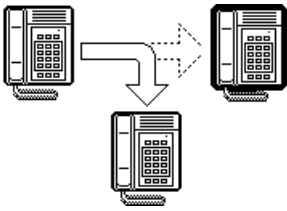

Divert All - Alias:

- Manager transfer.
- Secretary filter.

Divert No Answer - Alias:

- Divert no reply.

No Calls - Alias:

- Do not disturb.

Your phone can have diverts for different situations, ie. when busy, not answering or to divert all calls. You can also select no calls (*which uses the Divert All number if set*).

- **Divert on busy:** Calls divert when your phone is on a call. When set, callers cannot set a callback or camp on to your phone.
- **Divert on no answer:** Calls divert after ringing your phone for a set period (*see page 20*).
- **Divert all:** All calls to your phone are diverted. Only the extension to which you divert calls can ring you.
- **No calls:** Switching no calls on stops **all** calls. Callers hear continuous tone or divert to the divert all number if set.

Switching No Calls On/Off

If you switch on no calls after setting a divert all number, it diverts all callers and even the divert extension cannot call you. If you switch it on without setting a divert all number, all callers hear continuous tone.

Whilst on, you hear a repeated single pip if you lift the handset, but you can still make calls. Switching no calls on takes the phone out of group. **Note:** Your System Manager can prevent use of the no calls feature.

To switch no calls on/off:

1. Lift the handset and immediately dial *0.
2. **Broken dial tone:** Dial **60** (*no calls on*) or **61** (*no calls off*).
3. **Broken dial tone:** Replace the handset to finish.

Switching a Divert On

A divert is switched on by setting a divert number. It is switched off by cancelling that number.

When divert all is on, you hear a repeated single pip if you lift the handset but you can still make calls. Switching divert all on takes the phone out of group and no calls.

To set a divert number:

1. Lift the handset and immediately dial *0.
2. **Broken dial tone:** Dial **10** (*divert all*), **11** (*divert on busy*) or **12** (*divert on no answer*).
3. **Loud pip:** Dial the phone's 4-digit passcode (*see page 20*).
4. **Continuous tone:** Passcode wrong, replace the handset.
5. **Three soft-tones:** Divert number already set, either;
 - To stop, replace the handset.
 - To clear the stored number, press *.
6. **Single soft tone:** No divert number set, either;
 - To stop, replace the handset.
 - To set a divert number, press *, then the number followed by #.
7. **Continuous tone:** Invalid number, replace the handset.
8. **Broken dial tone:** Number entered okay, replace the handset.

Switching a Divert Off

A divert is switched off by cancelling the stored divert number. To do this, follow the process for setting a divert and press * to clear any stored number.

Other Features

The Phone Passcode



If the phone gives a loud pip, it requires you to dial its four-digit passcode. The default passcode is 0000. Wrong passcode entry more than 5 times results in the phone becoming barred. Barred phones cannot access features requiring passcode entry. They can make external calls but only to special numbers, eg. emergency numbers.

To change the phone's passcode:

1. Lift the handset and immediately dial *0.
2. **Broken dial tone:** Dial **70** (*passcode*).
3. **Loud pip:** Dial the phone's 4-digit passcode.
4. **Continuous tone:** Passcode wrong, replace the handset.
5. **Single soft tone:** Dial the new four-digit passcode.
6. **Broken dial tone:** Number okay, replace the handset to finish.

Group

The system can include your phone in a group (or even in several groups). You can then take your phone in and out of group. When 'in group', you may receive calls made to the group number. Going into group switches divert all and no calls off.

The group's type sets which group members the system rings when a call to the group arrives. The different types are rotary, collective, sequential and longest waiting (*see "Glossary" on page 26*).

To join/leave group:

1. Lift the handset and immediately dial *0.
2. **Broken dial tone:** Dial **40** (*in group*) or **41** (*out of group*).
3. **Broken dial tone:** Replace the handset to finish.

Conference Calls

"No grand idea was ever born in conference, but a lot of foolish ideas have died there" F.Scott Fitzgerald 1945.

During a call, other extensions can add callers to create a conference call. They can setup conferences including up to 64 parties(!). Standard phones cannot start or add calls to a conference but can be included in a conference. Quote.

To exit a conference:

1. Replace the handset. This does not affect any other callers involved in the conference.

Setting the Ringer Timeout

The ringer timeout controls several actions:

- **Callback:** How long a callback rings before cancelling.
- **Group hunting:** How long calls to a group of which you are a member, ring before trying another member.
- **Divert on no answer:** How long calls ring at your phone before the system uses Divert on No Answer if set.

To set the ringer timeout:

1. Lift the handset and immediately dial *0.
2. **Broken dial tone:** Dial 13 (*ringer timeout*).
3. **Loud pip:** Dial the phone's passcode (*see page 20*).
4. **Continuous tone:** Passcode wrong, replace handset.
5. **Three soft-tones:** Timeout already set, dial * to cancel.
6. **Single soft tone:** No timeout set, dial a new timeout (0 to 999 seconds - 10 seconds ≈ 3 rings) and then dial #.
7. **Broken dial tone:** Replace the handset to finish.

Personal Alarms

You can set a Personal Alarm for your phone. When it takes place, the phone will give a repeating triple ring for 20 seconds or until you lift and replace the handset.

- **To set or alter an alarm:**
Lift the handset and dial *8hhmm# where *hhmm* is the time in 24-hour clock format.
- **To clear an alarm before it occurs:**
Lift the handset and dial *8*#.

Voice Manager

Using Voice Manager

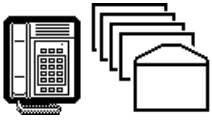

The system can include a Voice Manager to record messages for you in your own voice mailbox.

To switch voice mail on/off:

1. To switch voice mail usage on, set the Voice Manager number as your phone's diverts (*see page 18*). Cancel the diverts to stop voice mail.

Customising Your Mailbox

You can customise your mailbox in many ways. We strongly recommend that you set a passcode to keep your mailbox private.

To customise your mailbox:

1. Dial the Voice Manager extension number (_____).
2. When answered, dial # for the message desk.
3. Dial your ID. (_____) and your password if requested.
4. If you have fax messages, the Voice Manager will tell you. Dial **3** to skip fax collection.
5. Dial **7** and select one of the following.
 - **Record Name:** Dial **1**.
 - **Permanent Greeting:** Dial **4**. The Voice Manager plays this to callers diverted to your mailbox.
 - **Set Password:** Dial **2**. Do not set an obvious password such as 1234, 0000 or your extension number.
 - **Temporary Greeting:** Dial **0**. This replaces your permanent greeting until it is automatically deleted at a set time (__:__ am/pm).
 - **Fax Number:** Dial **5**. If your Voice Manager also takes fax messages, you can set a fax number to which it should forward your faxes (do not add the normal external dialling prefix).
 - **Message Light Number:** Dial **6**. The Voice Manager can light the lamp on some phones when you have new messages. The lamp goes off once you check your mailbox.
 - **Day Alert Number:** Dial **3**. During day service, the Voice Manager rings this number if you have new messages. This is not used if you set a message light number.

Collecting Voice Messages

Check your mail regularly. The system deletes new and old messages after set periods. You can check your mailbox from an external phone. It must have touch tone (MF) dialling with * and # keys.

After entering your mailbox the Voice Manager tells you how many messages you have and their type (new or old).

To collect voice messages:

1. Dial the Voice Manager extension number (_____).
2. When answered, dial # for the message desk.
3. Dial your ID. (_____) and your password if requested.
4. If you have fax messages, the Voice Manager tells you.
5. To skip collecting your faxes, dial 3.
6. To collect your faxes, dial 9. Dial a fax number to which to send the faxes (do not prefix 9).
7. The Voice Manager plays the newest voice message.
8. Use the options below to play/action your messages.

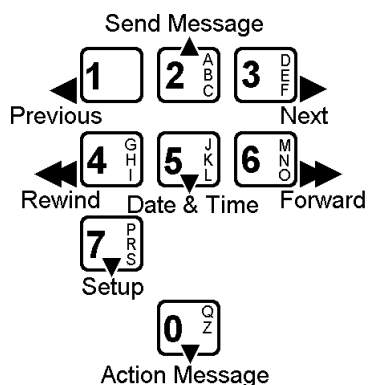

Playing Messages

While playing messages, use the following controls.

To play messages:

- To hear the next message: Dial 3.
- To hear the previous message: Dial 1.
- To rewind the message: Dial 4.
- To fast forward the message: Dials 6.
- To hear the message details (date, time & sender): Dial 5.
- To record a message in another mailbox: Dial 2.

Actioning Messages

While playing a message, you can action it in several ways:

To action a message:

- Dial 0 and select one of the following:
 - To delete the message: Dial #.
 - To copy the message to another mailbox: Dial 0.
 - To redirect the message to another mailbox: Dial 1.
 - To record a reply in the senders mailbox: Dial 2.
 - To call the sender: Dial 3.
 - To finish actioning the message: Dial *.

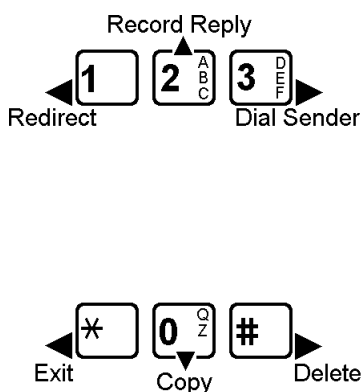

Good Phone Usage

General Phone Usage



The phone provides a quick method of communication. However, think carefully about how you use the phone. Your manner is a key part of the company's and your image. Since the phone does not convey smiles, shrugs, nods, etc, how you speak is all important.

- Speak clearly and maintain a friendly manner.
- Be precise and avoid rambling.
- Position the phone within easy reach for use.
- Keep a pen and paper near the phone and use them.
- Keep a list of company and external numbers handy.
- If you have to talk to someone else in the office during a call, inform the caller and then use hold (*see page 17*).
- Avoid giving your operator unnecessary work:
 - Transfer callers yourself rather than via the operator.
- Keep your System Manager informed of changes within your department, so that they can keep your pickup groups, phone directories, etc. up to date.

Answering Calls

"Speak now and I will answer; how shall I help you, say." **A.E.Houseman** 1896.

- Answer the phone promptly and identify yourself.
- Sound helpful and friendly.
- Get the callers name and use it.
- Do not be bad mannered to wrong numbers, always accept the apology. Transfer the call to the correct extension if you can (*see page 16*).
- Listen to the caller and let them know you are listening.
- If taking a message, include your name, the callers name, date, time and subject.
- If cut-off, wait for the original caller to call back.

Making Calls

"Well, if I called the wrong number, why did you answer the phone" **James Thurber**, *New Yorker Magazine* 1937.

- Know what you want to say, avoid rambling. If necessary prepare key point notes before the call.
- If you get a wrong number, always apologize, it is not the other person's fault.
- If cut-off, call back as soon as possible.
- If the extension diverts to Voice Mail, leave a message. Do not hold for the operator unless urgent.

Telephone Numbers

Personal Speed Dials

Store	Name	Number
00		
01		
02		
03		
04		

Store	Name	Number
05		
06		
07		
08		
09		

– To store a personal speed dial, see page 10.

System Speed Dials

Store	Name

Store	Name

Store	Name

Internal Phone Numbers

Extn	Name

Extn	Name

Extn	Name

Glossary

ACA

(Automatic Call Announcer) Equipment which plays messages to callers waiting to be answered.

ACCOUNT CODES

A code of up to 12 digits which the system outputs to its call log along with other call details. Codes entered are checked against up to 200 stored on the system before being accepted.

AREA

Each extension and line on the system belongs to one of up to 250 areas. They then follow the night service timetable linked to that area.

CALL LOG

The system can log calls that match set criteria, eg. length, direction, line, extension. The log includes call details such as number, account codes, time, etc.

CAMP ON

A function which leaves your phone set to ring a busy extension or line as soon as it becomes free and stops you receiving any other calls in the meantime.

COLLECTIVE GROUP

The system rings all the free members at the same time.

DT-3

Similar to DT-5 but with no BLF status lamps on the DSS keys.

DT-4

Similar to DT-5 but with no handsfree operation.

DT-5

Fully featured digital display phone. Includes full handsfree operation and 8 DSS keys with BLF status lamps.

LONGEST WAITING

The system tries the free members in order of how long they have been free, starting with the longest free.

MANAGER SECRETARY WORKING

A name for functions that help one user to make and receive calls for transfer to another user.

OFFLINE

A term used to mean out of service/not working.

PAGE

A one-way call which connects without ringing and uses the speaker of the phone(s) called. Also known as a broadcast call.

PICKUP GROUP

A group of phones within which you can pickup and answer calls ringing at any of the other member extensions.

PIN CODE

The system stores up to 200 PIN codes of up to 6 digits. Each PIN code has its own associated call barring and phone settings. When you use a PIN code, its settings temporarily override those of the phone from which you are dialling. Your System Manager will keep a record of the valid PIN codes stored on your system.

POT

(Plain Ordinary Phone) These are Alias two-wire telephones. POT's include devices such as fax machines and answerphones.

RECALL

A key which may also be marked **R** or **HOLD**.

ROTARY GROUP

The system starts with the first free member after the last member rung. If unanswered, after a short time the system tries the next free member and so on.

SEQUENTIAL GROUP

The system tries the first free members, always starting from the front of the group. If unanswered, after a short time the system tries the next free member and continues to shuttle between the first two free members.

SOFTWARE RELEASE

The release (or version/level) of software used by a system determines what features are available to users and how those features work.

SPEED DIALS

Speed dials are used to store phone numbers (and sometimes account codes). The number can then be dialled by entering just the number of the speed dial store.

SYSTEM MANAGER

The person responsible for the set up and maintenance of your phone system.

TENANCY

The system can be divided into several tenancies, each containing different extensions and lines. Calls between tenancies are not normally allowed. Each tenancy sub-divides into areas.

TT

(Turret Terminal) Similar to the INDeX DT phones, TT phones are designed for headset working in ACD (telephone sales) environments.

Index

- Actioning messages 23
- Alarms 21
- Alert number 22
- Answer calls 14
- Barred terminal 20
- Broadcast
 - Make 9
- Busy camp on 13
- Call
 - External 8
 - Make internal 9
- Call answer 14
- Call hold 17
- Call park 17
- Call pickup 15
- Callback 13
- Callback ring timeout 21
- Camp on 13
- Change passcode 20
- Collecting message 23
- Collecting voice mail 23
- Common hold 17
- Conference calls 20
- Copy message 23
- Customise mailbox 22
- Date
 - Message 23
- Day alert number 22
- Delete messages 23
- Dialling
 - Internal 9
- Dialling timeout 5
- Divert
 - Set numbers 19
- Divert all 18
 - Setup 19
- Divert no answer time 21
- Do not disturb 18
- Enter passcode 20
- Enter PIN 11
- Exclusive hold 17
- Extension
 - Page 9
- External call
 - Making 8
 - Redial 8
- Fast forward 23
- Fax collection 23
- Fax number 22
- Greeting 22
- Group
 - Joining/leaving 20
 - Page 9
- Group ringing timeout 21
- Hold 17
- Hotline operation 9
- Hunt group 20
- In Group 20
- Internal call
 - Make 9
- Last number redial 8
- Mailbox
 - Collection 23
- Mailbox customise 22
- Make call
 - External 8
 - Internal 9
 - Redial 8
- Manager transfer 18
- Message
 - Leave 12
- Message light number 22
- Messages - Actioning 23
- Mobile access 11
- Name mailbox 22
- Next message 23
- Night service
 - Effects of ... 5
- No calls
 - On/off 18
- Out of Group 20
- Page
 - Make 9
- Park calls 17
- Passcode
 - Mailbox 22
- Passcode - Terminal 20
- Permanent greeting 22
- Personal alarms 21
- Pickup 15
- Pickup group 15
- Pilot group 20
- PIN codes
 - Roaming 11
- Play messages 23
- Previous message 23
- Record message 23
- Redial 8
- Redirect 23
- Reply to message 23
- Rewind message 23
- Ringback 13
- Ringer timeout 21
- Ringling 5
- Roaming PIN 11
- Saved number redial 8
- Secretary filter 18
- Setup mailbox 22
- Speak to sender 23
- Take other calls 15
- Temporary greeting 22
- Terminal passcode 20
- Time
 - Message 23
- Timeout
 - Dialling 5
 - Ringer 21
- Tones 5
- Unpark calls 17
- Voice mail collection 23
- Voice Manager
 - Collecting messages 23
 - Mailbox customise 22
- Wait on busy 13

"So essential did I consider an Index to be to every book, that I proposed to bring a Bill into parliament to deprive an author who publishes a book without an Index of the privilege of copyright ; and, moreover, to subject him, for his offence, to a pecuniary penalty" **Lord Chief Justice Baron Campbell 1861.**

Performance figures and data quoted in this document are typical, and must be specifically confirmed in writing by Lucent Technologies before they become applicable to any particular order or contract. The company reserves the right to make alterations or amendments to the detailed specifications at its discretion. The publication of information in this document does not imply freedom from patent or other protective rights of Lucent Technologies, or others.

All trademarks acknowledged. SDX and INDeX are registered trademarks of SDX Business Systems, a wholly owned subsidiary of Lucent Technologies.

©SDX Business Systems, a wholly owned subsidiary of Lucent Technologies 1999.

Sterling Court
15 - 21 Mundells
Welwyn Garden City
Hertfordshire AL7 1LZ
England
Tel: +44 (0) 1707 392200
Fax: +44 (0) 1707 376933
Email: contact@sdxplc.com
Web: <http://www.sdxplc.com>

